

Bitpipe™ Devkit Board

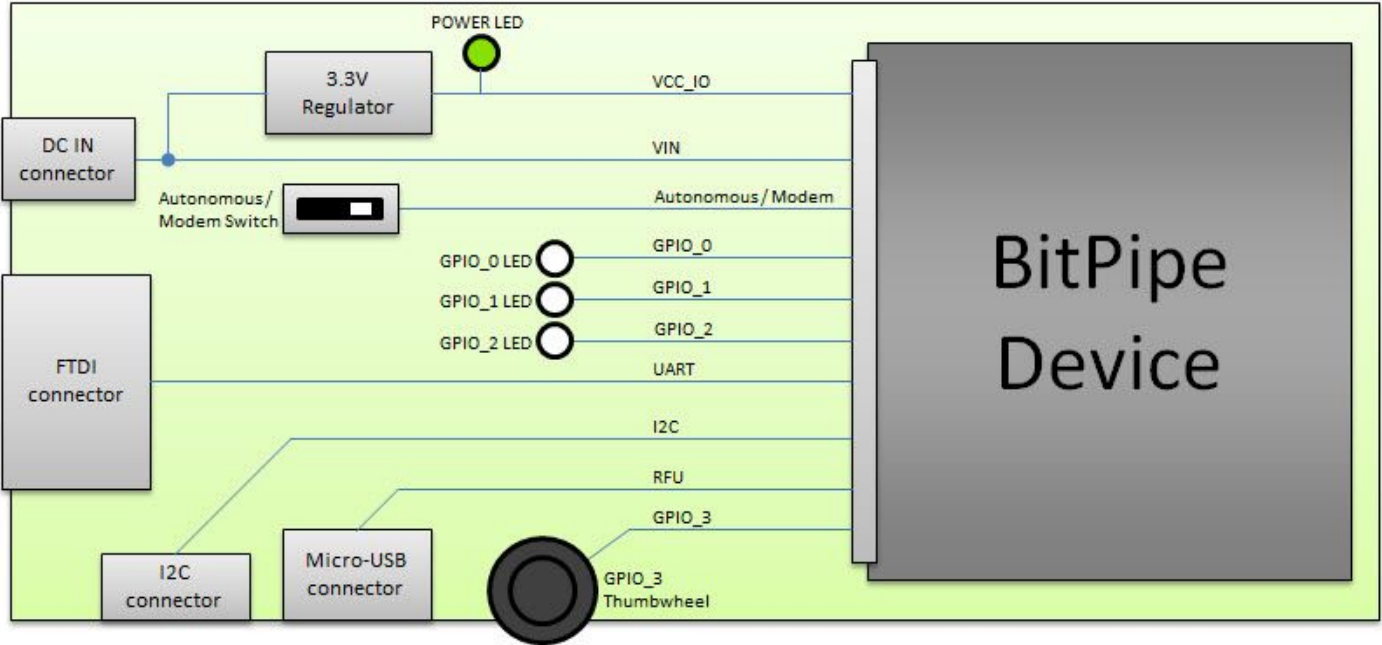

Title: Bitpipe Devkit Board	
Project: ADPT-BP-DEMO	Rev: 110-A
Client: Briowireless	
Date: 2016-11-21	Page: 1 of 2
Drawn by: Pascal Seguin	
Verified by: Sylvain Ainsley	
File: TopSheet.SchDoc	
<small>© COPYRIGHT 2016 BRIOWIRELESS INC. 4593 Louis-B. Mayer, Laval, Canada (QC), H7P 6G5</small>	

Barrel Connector & DC-DC 3V3

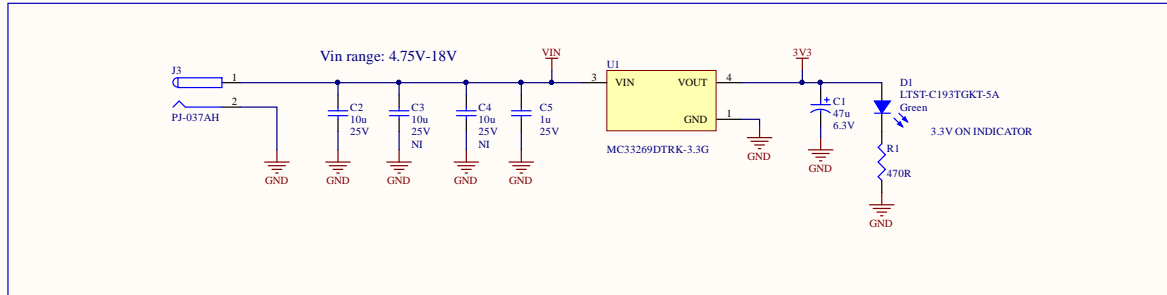

BitPipe Mating Connector

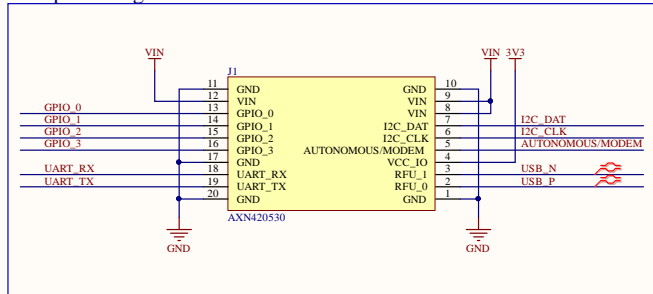

USB Connector

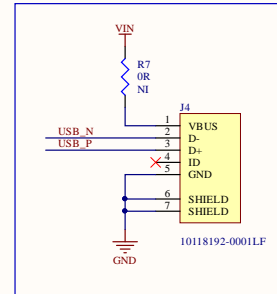

I2C Connector

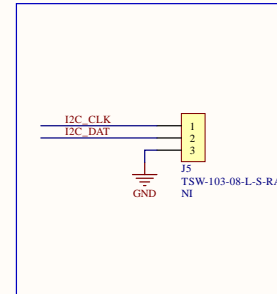

FTDI Connector

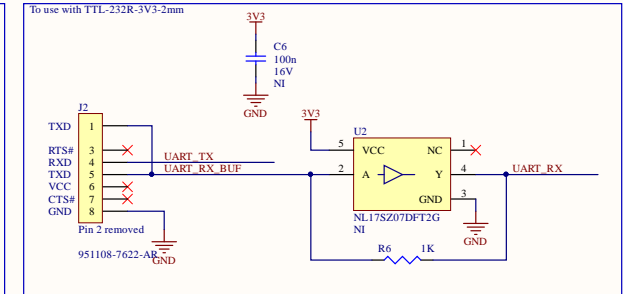

Output LEDs

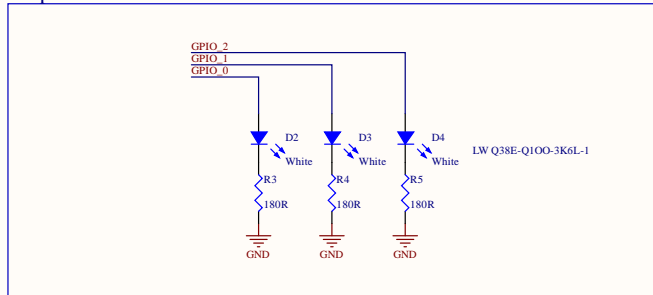

User Potentiometer

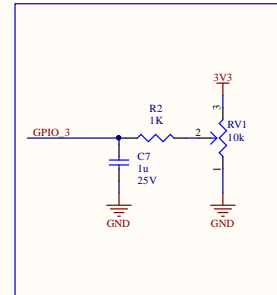

Auto Connect Switch

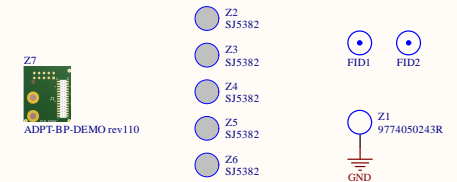
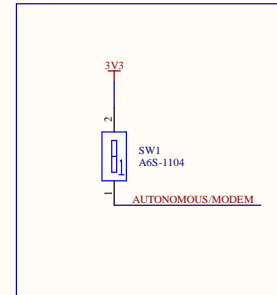

Bitpipe Devkit Board		
Project:	ADPT-BP-DEMO	Rev: 110-A
Date:	2016-11-22	Page: 2 of 2
File:	Bitpipe_Devkit_Board.SchDoc	
© COPYRIGHT 2016 BRIOWIRELESS INC. 4593 Louis-B. Mayer, Laval, Canada (QC), H7P 6G5		